

1

2

3

4

A

B

C

D

E

F

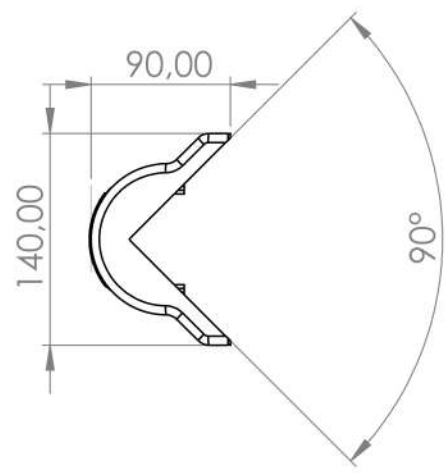
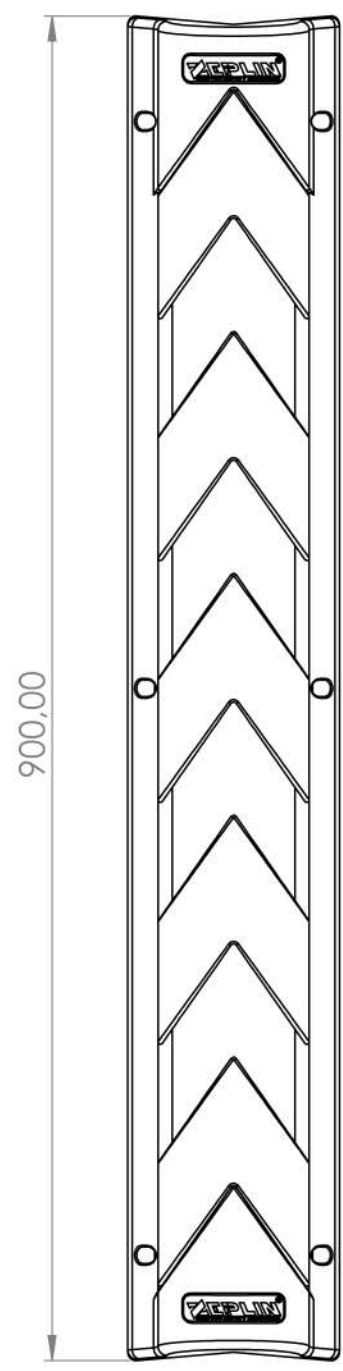

	NAME -SURNAME	DATE	SIGN	MATERIAL	MASS (KG)	REVISION NO	PAGE NR
DRAWN BY		---					1/2
CONTROL		---		STOCK CODE			
APPROVAL		---					
SCALE	1:10						
PART/ASSEMBLY NAME				DRAWING DESCRIPTION		DRAWING NO	FORMAT
				---		---	A4